

# Installation Guide For Styles Large Floating Flush Mount

## Tools Required

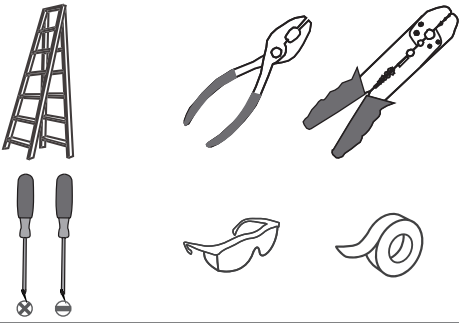

## Light Source

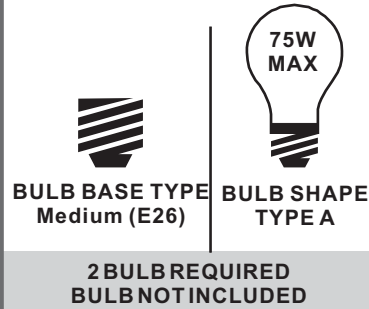

## Warnings and Cautions

Turn off the electricity at the circuit breaker before installation. Consult a licensed electrician if in doubt about installation.

Turn off power to the fixture and allow the bulbs to cool before replacing.

## Package Contents

**Preparation:** Identify and inspect all parts before beginning the installation.

Missing or damaged parts? Contact your original place of purchase.

### PARTS BAG

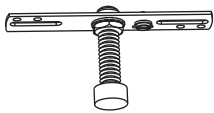

**A** Crossbar Assembly x 1



**C** Outlet Box Screw x 2



**B** Wire Connector x 3

**D** Fixture Body x 1

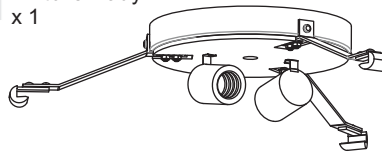

**E** Shade x 1

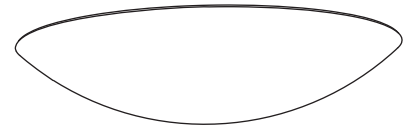

**Note:** Shade shape is for illustration purpose only. Your shade shape may vary from illustration.

## Table of Contents

### Crossbar Assembly

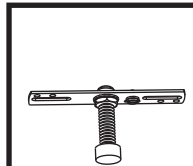

STEP 1

### Wiring

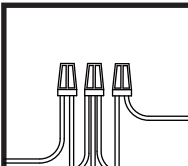

STEP 2

### Fixture Body

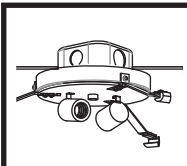

STEP 3

### Shade & Bulb

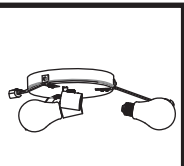

STEP 4

## STEP 1

1

**Step 1**  
Install crossbar assembly

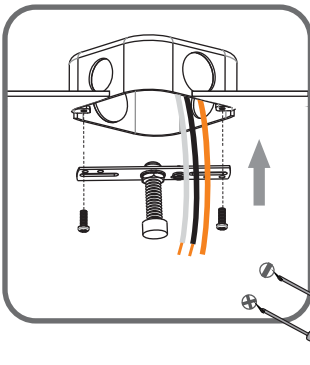

2

**Step 2 - 3**  
Test fitting ceiling canopy to nipple

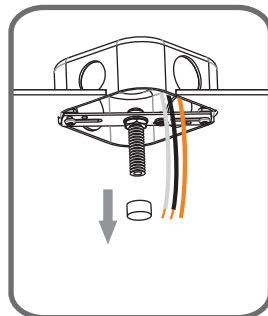

3

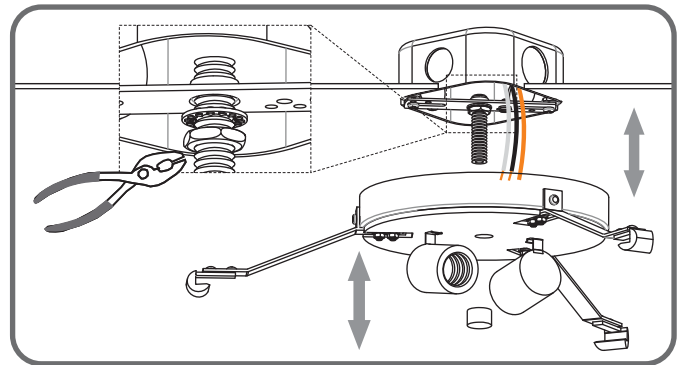

## STEP 2

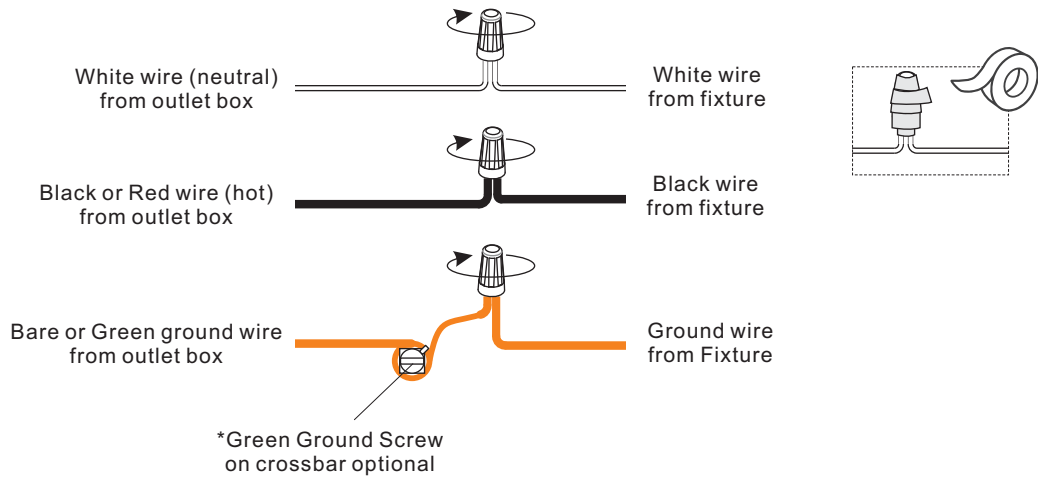

## STEP 3

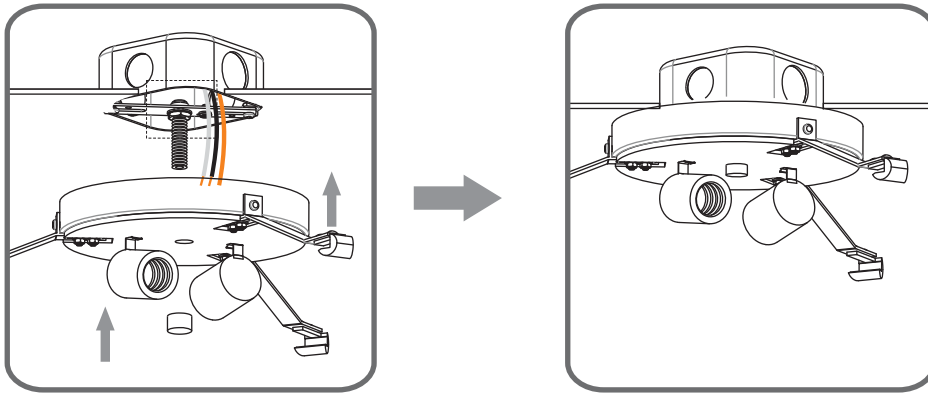

## STEP 4

