

Tools Required

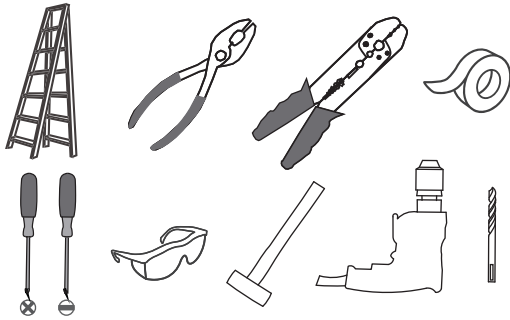

Light Source

27W
LED

Warnings and Cautions

Turn off the electricity at the circuit breaker before installation. Consult a licensed electrician if in doubt about installation.

Package Contents

Preparation: Identify and inspect all parts before beginning the installation.

Missing or damaged parts? Contact your original place of purchase.

PARTS BAG

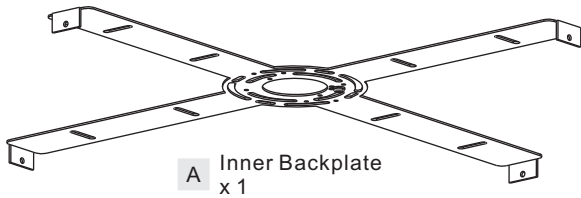

A Inner Backplate
x 1



B Wall Anchor
x 4



E Mounting Screw
x 4



C Flat Washer
x 4



F Outlet Box Screw
x 2



D Screw
x 4



G Wire Connector
x 3



H Fixture Body
x 1

Table of Contents

Inner Backplate

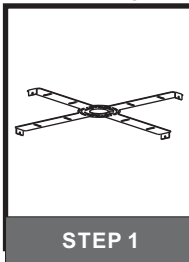

Wiring

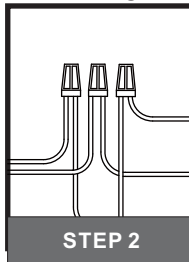

Fixture Body

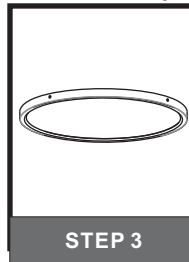

STEP 1

1

Fit inner backplate to outlet box

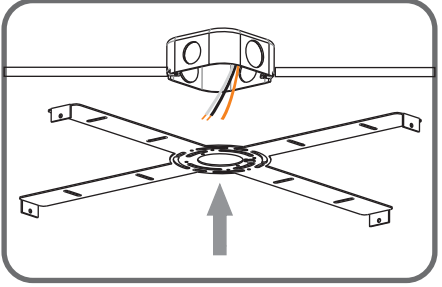

2

Mark anchor holes location on the ceiling

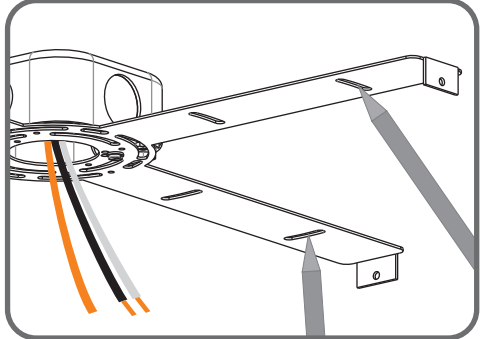

3

Drill holes for anchors from marks

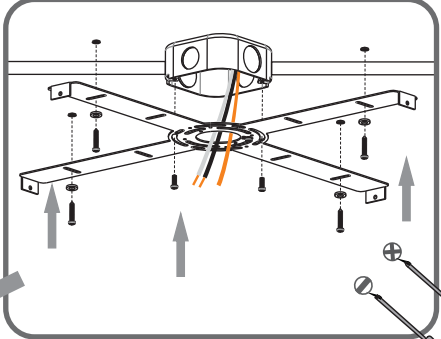
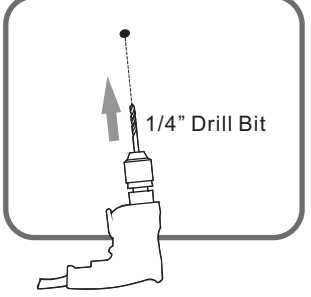

Install inner backplate

5

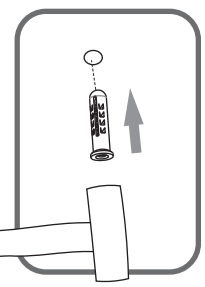

Install wall anchors

4

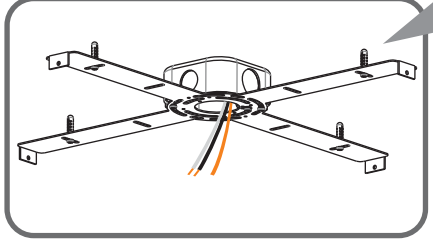

STEP 2

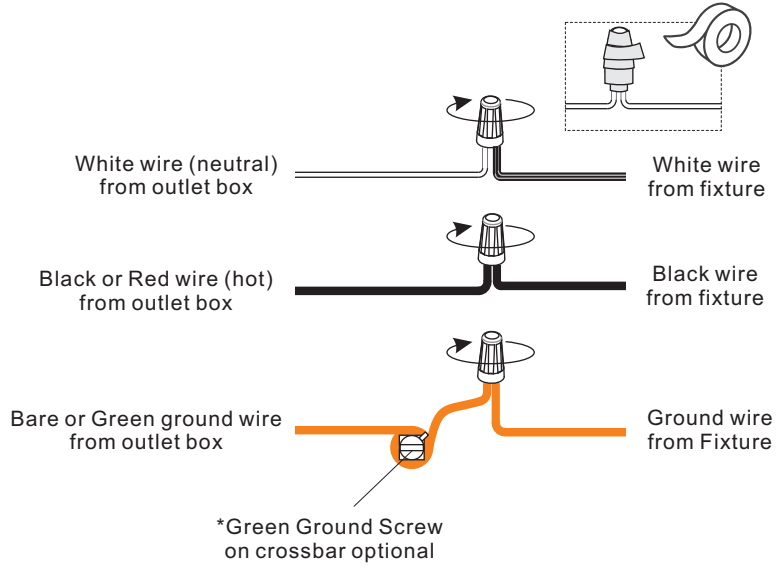

STEP 3

