

Please go to [www. quozel. com](http://www. quozel. com) for product cleaning tips. Go to the **Care + Maintenance** selection.

**Tools Required:** Flathead screwdriver, Phillips screwdriver, pliers, wire cutters, wire strippers, electrical tape, safety glasses.

**Light Source:** (2) A19 Medium Base bulbs 100W Maximum or  
(2) Medium Base Vintage bulbs are recommended but not supplied.

**Estimated Assembly Time:** 30-45 minutes

**Preparation:** Identify and inspect all parts before beginning installation. Check package content list and diagrams below to be sure all parts are present. If any parts are missing or damaged, do not attempt to assemble, install, or operate the fixture. Contact customer service for replacement parts.

## ⚠ Warnings and Cautions

Turn off electricity at circuit breaker or main fuse box before installation. Consult a licensed electrician if in doubt.

These instructions are provided for your safety. It is very important you read them completely before installing the fixture. We strongly recommend that a licensed, professional electrician perform the installation.

Disconnect fixture from power source before replacing bulbs. Make sure bulbs are given sufficient time to cool before removal.

## Package Contents

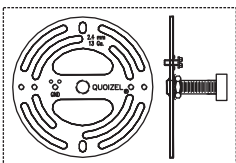

**A** Crossbar Assembly  
x 1

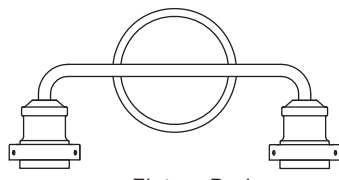

**B** Fixture Body  
x 1

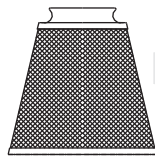

**C** Shade  
x 2

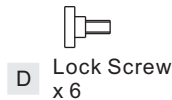

**D** Lock Screw  
x 6

## STEP 1 - Install Crossbar

A. Attach the Crossbar (A) to the Outlet Box with the head of the Green Ground Screw facing you. Secure it with Outlet Box Screws (not included). Tighten until snug.

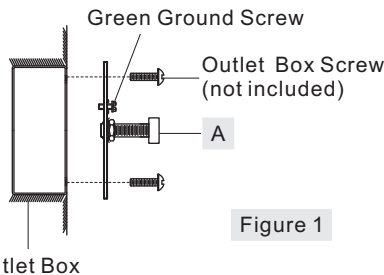

Figure 1

## STEP 2 - Test Fit the Backplate to the Crossbar Assembly

a. Remove lock ball from crossbar assembly.

b. Fit backplate of Fixture Body (B) over the nipple on Crossbar Assembly (A) and secure with lock ball.

**Note:** The backplate should be snug against the wall and the lock ball. If not, adjust the length of the nipple on the Crossbar Assembly (A) by unscrewing the preassembled hex nuts. Then, screw the nipple in or out of the crossbar until the desired length is achieved. Once the backplate is secure, remove the lock ball and backplate and proceed to Step 3.

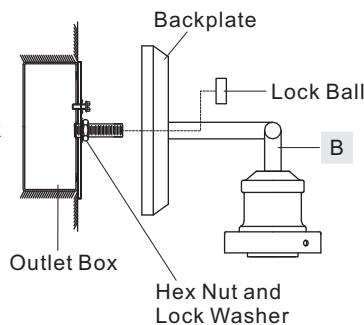

Figure 2

## STEP 3 - Wire Connections

A. Wrap bare or green ground wire around green ground screw on the crossbar, no less than 2 inches from the end of the wire. Tighten the green ground screw.  
B. Use standard wire connectors (not included) to make all wire connections. Twist connectors until wires are tightly joined together. Wrap each connection with approved electrical tape and carefully stuff all the connected wires into the Outlet Box.

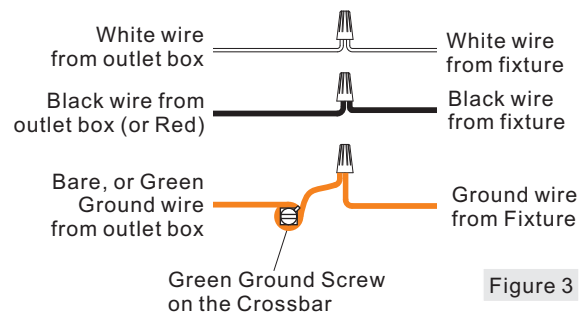

Figure 3

## STEP 4 - Install Fixture Body

A. Re-attach the backplate and Fixture Body (B) to the Crossbar Assembly (B). Secure with the previously removed lock ball.

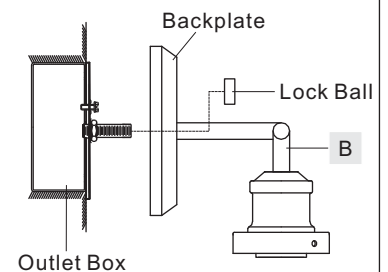

Figure 4

## STEP 5 - Install Shade and Bulb

A. Place Shade (C) into the socket cup with the joint of the mesh is against the backplate. Thread Lock Screws (D) onto socket cup to engage the neck of the Shade (C). Carefully release your hands after all Lock Screws (D) are tightened properly.  
B. Insert bulbs onto sockets and screw snugly into place.

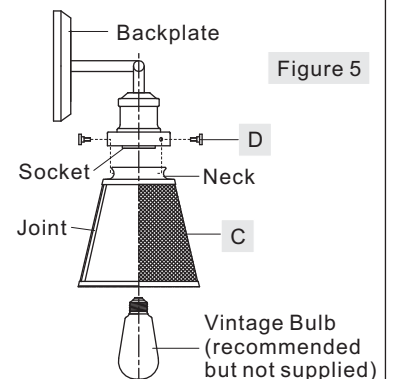

Figure 5

Your fixture is now assembled and ready to use. Enjoy!

**Thank you for purchasing a Quoizel product.**  
**Need assistance with parts or assembly? Call Quoizel customer service at 1-800-645-3184**  
**or visit us on-line at [www. quozel. com](http://www. quozel. com)**

VLT8602WT

FINISH: WESTERN BRONZE

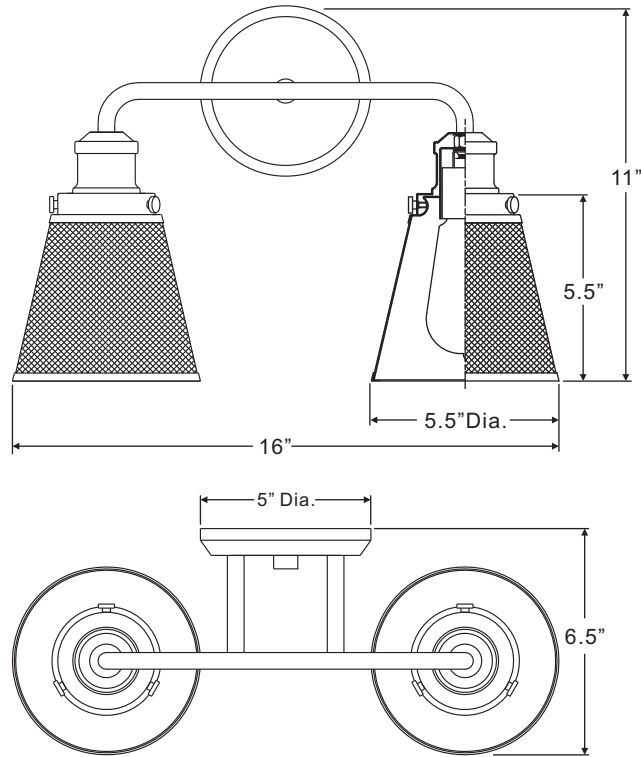

NOTE: ALL DIMENSIONS ARE ROUNDED UP TO THE NEAREST 1/4"

Thank you for purchasing a Quoizel product.  
Need assistance with parts or assembly? Call Quoizel customer service at 1-800-645-3184  
or visit us on-line at [www.quoizel.com](http://www.quoizel.com)