

Installation Guide For Styles Medium Floating Flush Mount

Tools Required

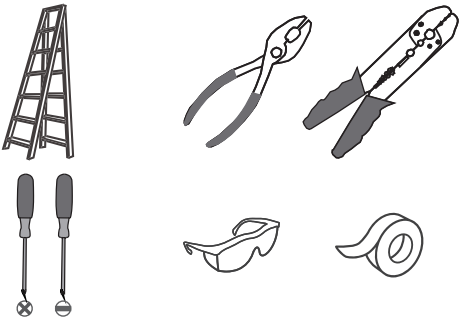

Light Source

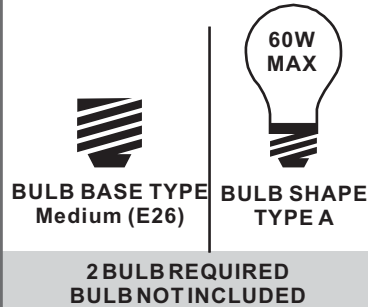

Warnings and Cautions

Turn off the electricity at the circuit breaker before installation. Consult a licensed electrician if in doubt about installation.

Turn off power to the fixture and allow the bulbs to cool before replacing.

Package Contents

Preparation: Identify and inspect all parts before beginning the installation.

Missing or damaged parts? Contact your original place of purchase.

PARTS BAG

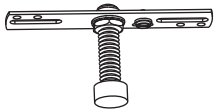

A Crossbar Assembly x 1



C Outlet Box Screw x 2



B Wire Connector x 3

D Fixture Body x 1

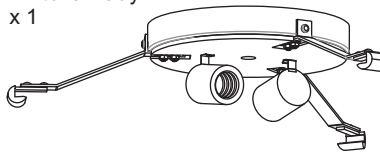

E Shade x 1

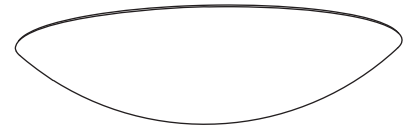

Note: Shade shape is for illustration purpose only. Your shade shape may vary from illustration.

Table of Contents

Crossbar Assembly

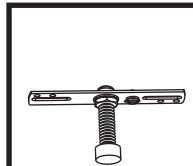

STEP 1

Wiring

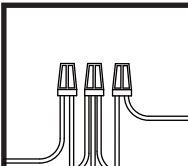

STEP 2

Fixture Body

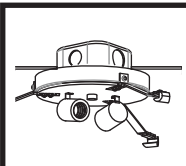

STEP 3

Shade & Bulb

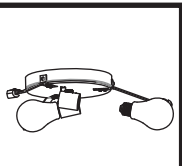

STEP 4

STEP 1

1

Step 1
Install crossbar assembly

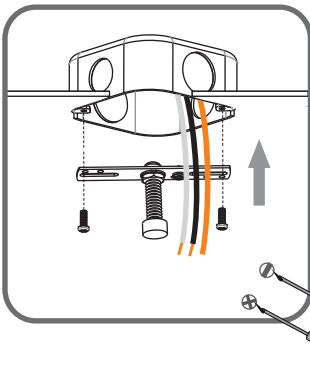

2

Step 2 - 3
Test fitting ceiling canopy to nipple

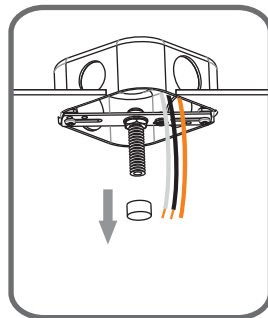

3

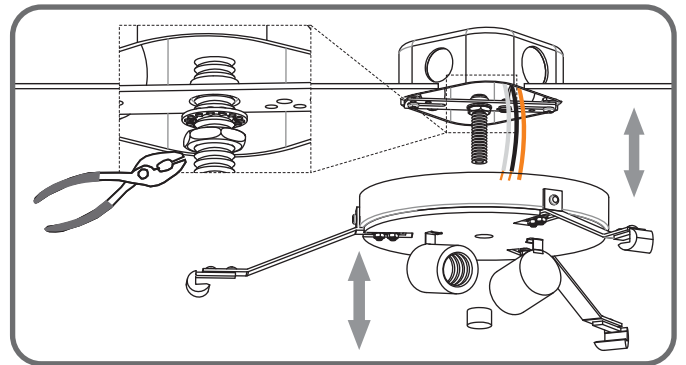

STEP 2

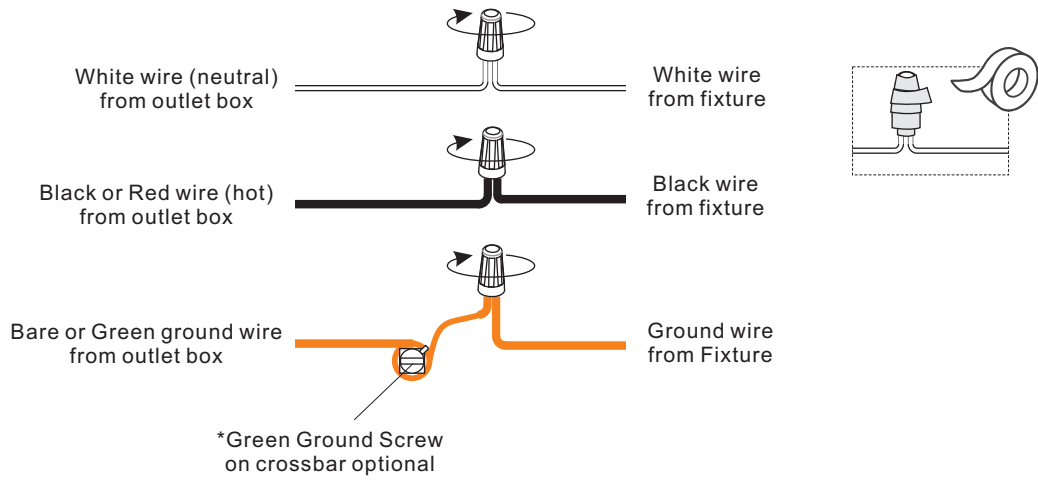

STEP 3

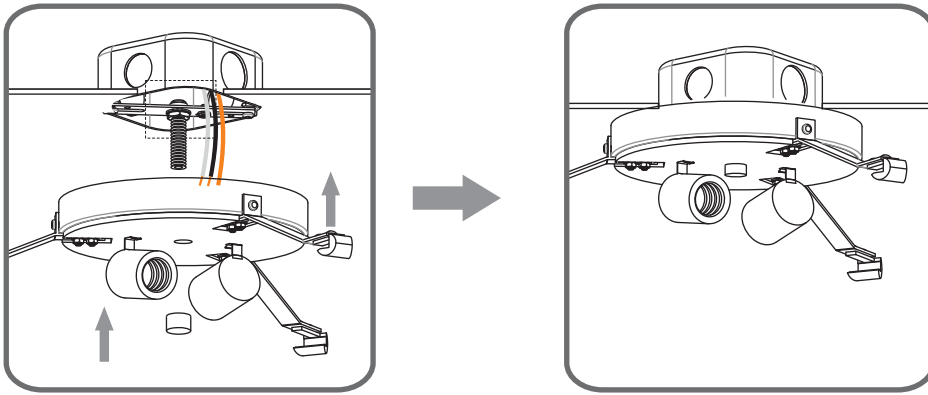

STEP 4

